



# WirelessAIR™

Kit Number  
**73000EZ**

App Only, No Controller with EZ Mount™

## Installation Guide

### Introduction

WirelessAIR™ App only, No Controller with EZ Mount™ combines a manifold and compressor into a single, easy-to-install unit, along with wiring harness and accessories needed to connect to vehicle power and air springs (purchased separately).

#### IMPORTANT: PLEASE READ BEFORE INSTALLING

IT IS IMPORTANT TO READ AND UNDERSTAND THE ENTIRE INSTALLATION GUIDE BEFORE BEGINNING INSTALLATION OR PERFORMING ANY MAINTENANCE, SERVICE OR REPAIR. THE INFORMATION HERE INCLUDES A HARDWARE LIST, STEP-BY-STEP INSTALLATION INFORMATION AND SAFETY INFORMATION.

#### USING THE SYSTEM

Refer to the WirelessAIR™ User Guide included with this kit to learn how to operate the system and connect your mobile device to the system.

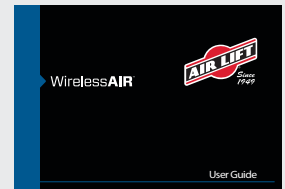

\*Smart phone not included

### NOTATION EXPLANATION

Hazard notations highlight information that must be observed to help minimize risk of personal injury or possible improper installation, which may render the vehicle unsafe.



INDICATES IMMEDIATE HAZARDS WHICH WILL RESULT IN SEVERE PERSONAL INJURY OR DEATH.



INDICATES HAZARDS OR UNSAFE PRACTICES WHICH COULD RESULT IN SEVERE PERSONAL INJURY OR DEATH.



INDICATES HAZARDS OR UNSAFE PRACTICES WHICH COULD RESULT IN DAMAGE TO THE MACHINE OR MINOR PERSONAL INJURY.

### TOOLS LIST

Description.....	Qty	Description.....	Qty
Power drill.....	1	Wire stripping/crimping tool.....	1
1/4", 3/8" Drill bits.....	1 ea.	Sharp razor knife.....	1
3/8", 1/2", 5/16", 9/16" Sockets & ratchet.....	1 ea.		

## HARDWARE LIST

Item	Part #	Description.....	Qty
A	26564	EZ Mount assembly .....	1
	72710-W	Manifold .....	1
	16192	Compressor .....	1
B	20946	Air line (1/4") .....	25 ft.
C	26897	Wiring harness .....	1
<b>Hardware Pack:</b>			
D	21838	Tee 1/4" PTC .....	2
E	24652	ATC fuse, spade 15A .....	1
F	24752	Heat shrinkable butt splice 10-12 ga.....	2
G	24500	Fuse holder ATC/ATO .....	1
H	10466	8" Zip tie .....	18
I	24748	3/8" Ring terminal 10-12 ga.....	1
J	11104	U-bolt.....	1
K	18435	3/8"-16 Nylon lock nut.....	2
L	18444	3/8" Flat washer.....	4
M	17188	3/8"-16 x 1 1/4" Hex cap bolt.....	2
N	17102	5/16"-18 x 3/4" Self-tapping hex screw .....	2
O	10868	Tree mount.....	3
P	24661	Heat shrinkable butt splice 14-16 ga.....	1
Q	24681	3/8" Ring terminal 14-16 ga.....	1

## SUGGESTED COMPONENT LAYOUT

This guide should be used as a general reference (Fig. 2). The layout may need modification based on the application.

- Ideally, EZ Mount should be mounted in the middle of the vehicle in the zone marked by the yellow square to optimize the wireless performance.
- Avoid routing air lines and wiring near sharp edges. If passing air lines or wiring through holes in the frame, use rubber grommets. Support wiring and air lines every 8-12" with zip ties (H) or other means.
- Keep wiring, air lines and EZ Mount at least 6" away from heat sources such as the exhaust.

### CAUTION

DO NOT MOUNT EZ MOUNT WITH THE LOGO UPSIDE DOWN OR THE LOGO FACING THE GROUND (FIG. 1).

DO NOT HANG EZ MOUNT FROM A HORIZONTAL SURFACE USING SELF-TAPPING SCREWS.

PLACE THE COMPONENTS AND ROUTE THE AIR LINES AND WIRING HARNESS TO AVOID HEAT SOURCES SUCH AS THE EXHAUST SYSTEM.

PROTECT AIR LINES AND WIRING WHEN ROUTING NEAR SHARP EDGES.

LOCATE EZ MOUNT IN AN AREA OF THE VEHICLE WHERE IT WILL BE SHIELDED FROM DIRECT SPLASH. EXCESSIVE MOISTURE CAN DAMAGE THE COMPRESSOR AND CAUSE SYSTEM FAILURE.

REMOVE ALL FUSES WHEN JUMP-STARTING OR WELDING ON THE VEHICLE. FAILURE TO DO SO COULD DAMAGE THE MANIFOLD.

TO KEEP VOLTAGE DROP WITHIN INDUSTRY STANDARDS, DO NOT EXTEND WIRES. EXTENDING THE WIRES COULD DECREASE COMPRESSOR LIFE.

**Wiring to the battery**

**CAUTION**  
INSTALL THE FUSE AFTER ALL CONNECTIONS ARE MADE.

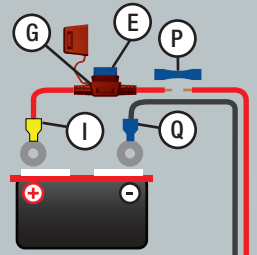

**Ignition Source Connection**

Connect the pink wire to any wire that is active when the ignition is on. This will allow WirelessAIR to only make adjustments when the ignition is turned on.

Refer to SB-303, included with your system, for ignition integration details.

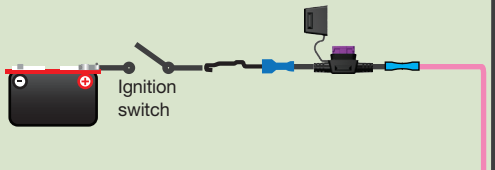

**EZ Mount (Manifold & Compressor)**

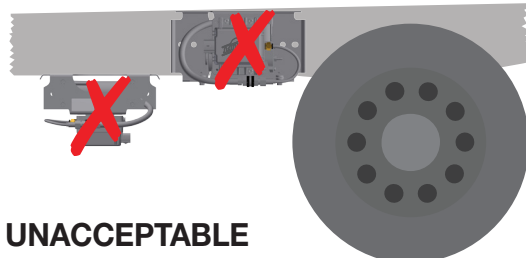
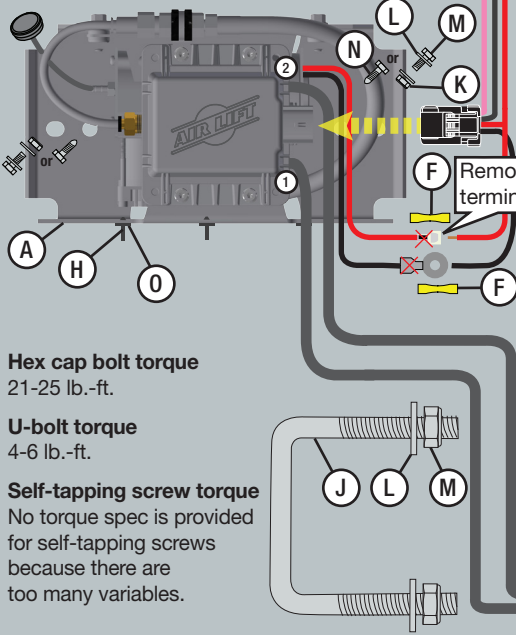

**UNACCEPTABLE MOUNTING ORIENTATIONS**

fig. 1

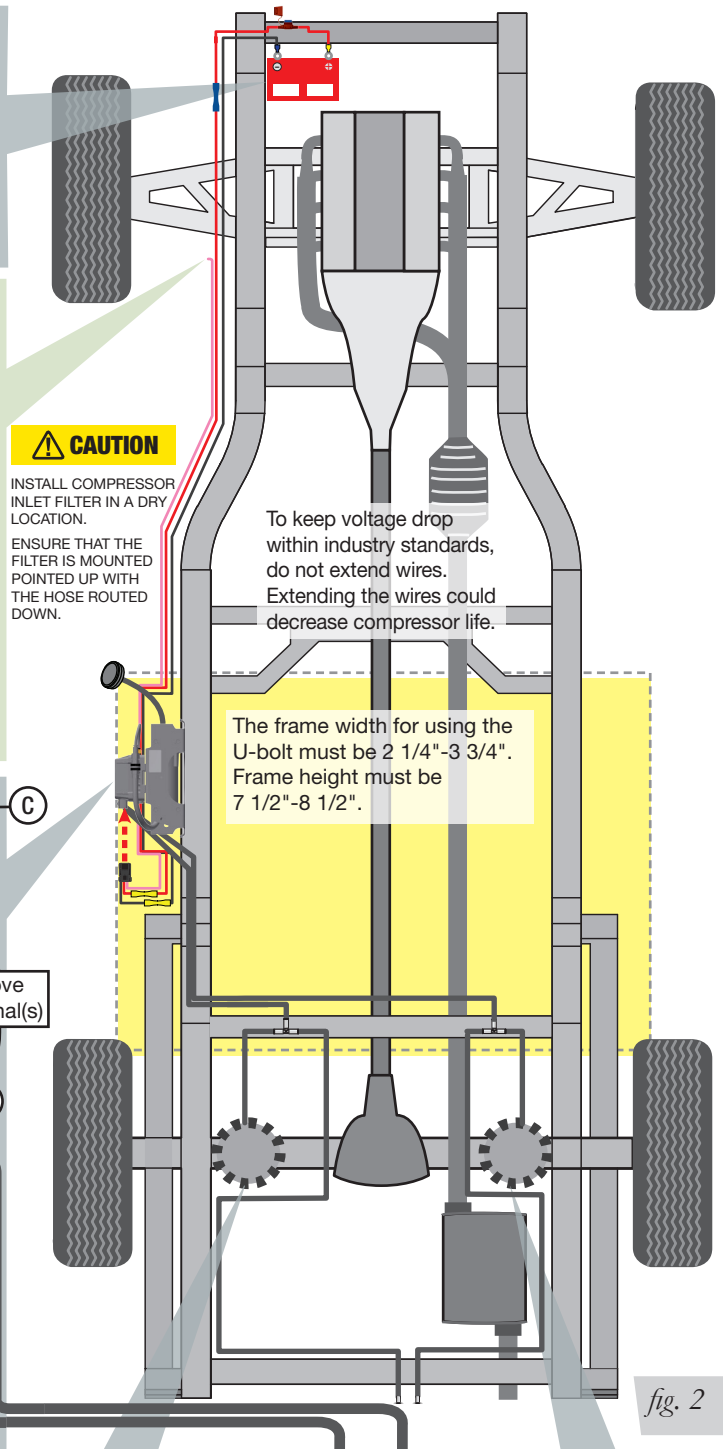
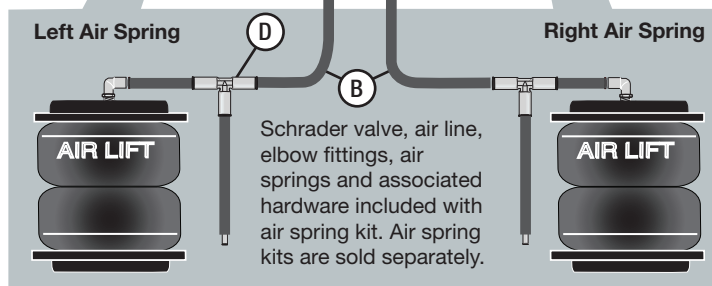

fig. 2



# Installing WirelessAir EZ Mount

- There are three choices for mounting:
  - Hex cap bolts (M) with flat washers (L) and nylon lock nuts (K).
  - U-bolt (J) with washers (L) and nylon lock nuts (K). See Figure 3 for U-bolt installation.
  - Self-tapping screws (N).
- EZ Mount can be mounted in any orientation except with the logo upside down or the logo facing the ground (Fig. 1). There are mounting holes in the side of the bracket and in the top. Use the included template (Fig. 5) for mounting with self-tapping screws or hex cap bolts. Use a 1/4" drill bit to make pilot holes if using self-tapping screws.

## CAUTION

BEFORE DRILLING, ENSURE THAT THE BACK SIDE IS CLEAR OF VEHICLE COMPONENTS, INCLUDING BRAKE LINES, FUEL LINES, AND WIRING.

- Do not remove components from the EZ Mount assembly.



U-bolt installation

fig. 3

## REMOTE FILTER INSTALLATION

- Screw 1/4" FNPT x 1/4" barbed tube fitting onto inlet air filter, hand-tighten. No thread sealant needed.
- Attach 1/4" air line, provided in the filter pack, to barbed tube fitting on remote inlet air filter.
- Locate appropriate area where remote inlet filter is to be installed. Keep in mind that location should be dry and away from heat source, and that the air inlet slots on the inlet air filter are free from blockage.
- Secure remote filter appropriately using proper fastening methods or drill a 3/8" mounting hole and push remote filter bracket pin into the mounting hole.
- Route air line to inlet port of the compressor. Measure and cut squarely to appropriate length (Fig. 9). Make sure when routing you keep away from sharp edges and you allow for proper bend radius (see *Cutting the Air Lines*) to avoid kinking.
- Attach cut end of 1/4" air line to barbed tube fitting of air inlet port on compressor.

## AIR LINE AND WIRING CONNECTIONS

- Route and install an air line (B) from port (1) of the manifold to the driver's (left) side air spring. Route and install an air line (B) from port (2) of the manifold to the passenger's (right) side air spring (Fig. 2). Install tee fittings (D) and Schrader valves if manual inflation is desired (Fig. 2). To ensure a proper and clean cut, see *Cutting the Air Lines*.
- Route the wiring harness (C) along the frame and make all wiring connections (Fig. 2).
- Cut off the terminals on the red and black compressor wires and connect to the short red and black wires on the wiring harness (C) using butt splices (F) (Fig. 2). The ground wire cannot be grounded to the chassis and must be connected to the harness. Finish by connecting the wiring to the battery. Wait to install the fuse.
- Attach the wiring harness to the top (preferred) or bottom of the EZ Mount bracket with tree mounts (O) and zip ties (H) (Fig. 4).

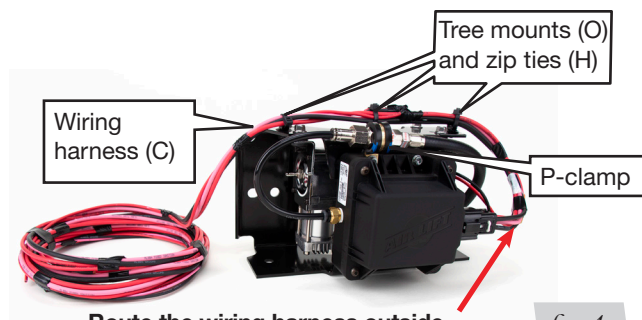

Route the wiring harness outside of the compressor hose.

fig. 4



## DRILLING TEMPLATE VERIFICATION



### CAUTION

IMPORTANT: PRINT THIS PAGE AT 100% SCALE. THIS IS A DRILLING TEMPLATE, WHICH WOULD BE RENDERED INCORRECT IN DIMENSION IF PRINTED WITH ANY SCALING. USING AN INCORRECT TEMPLATE TO DRILL HOLES MAY CAUSE DAMAGE TO THE VEHICLE! PLEASE REFER TO THE ONE-INCH SCALE AND USE A MEASURING TOOL TO CONFIRM THAT THE PRINTED SCALE MEASURES 1" TO VERIFY THAT THE TEMPLATE HAS BEEN PRINTED AT 100% SCALE.

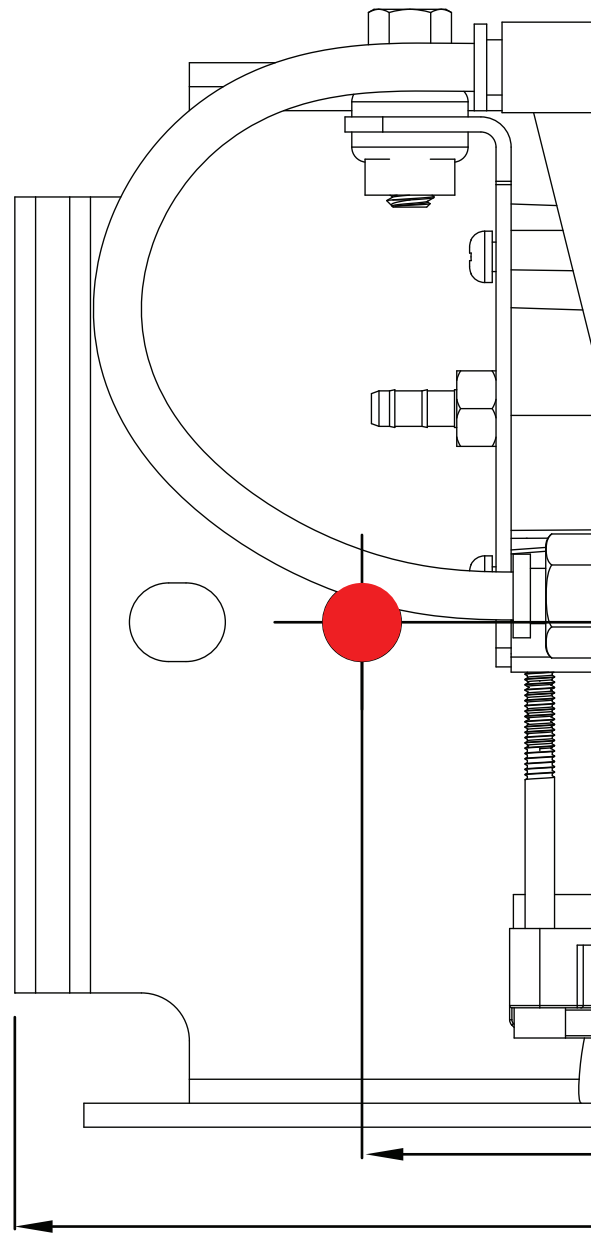

**SIDE**

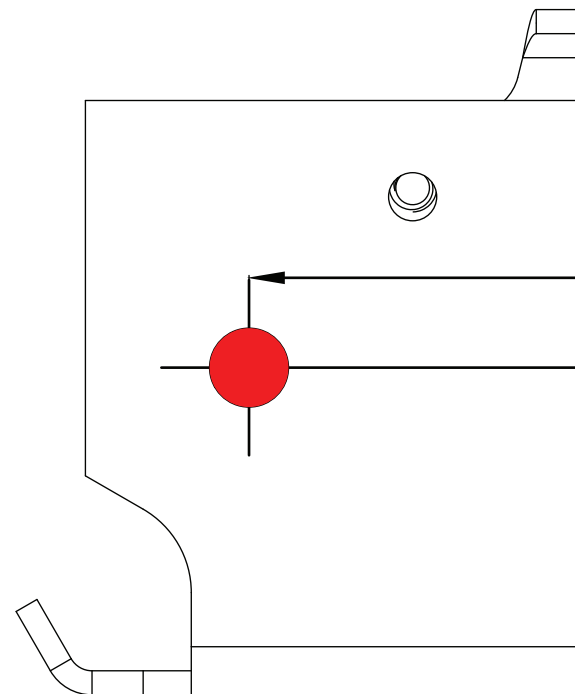

**TOP**

*fig. 5*

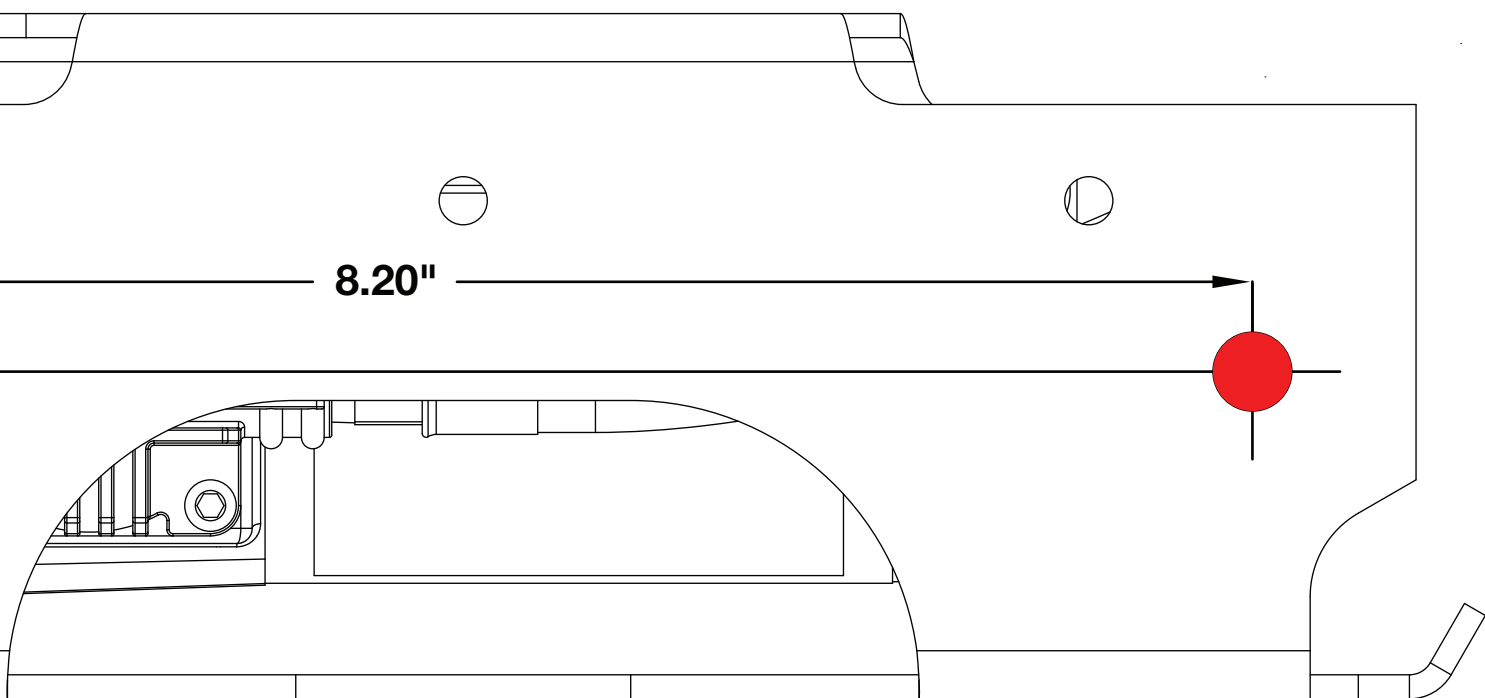
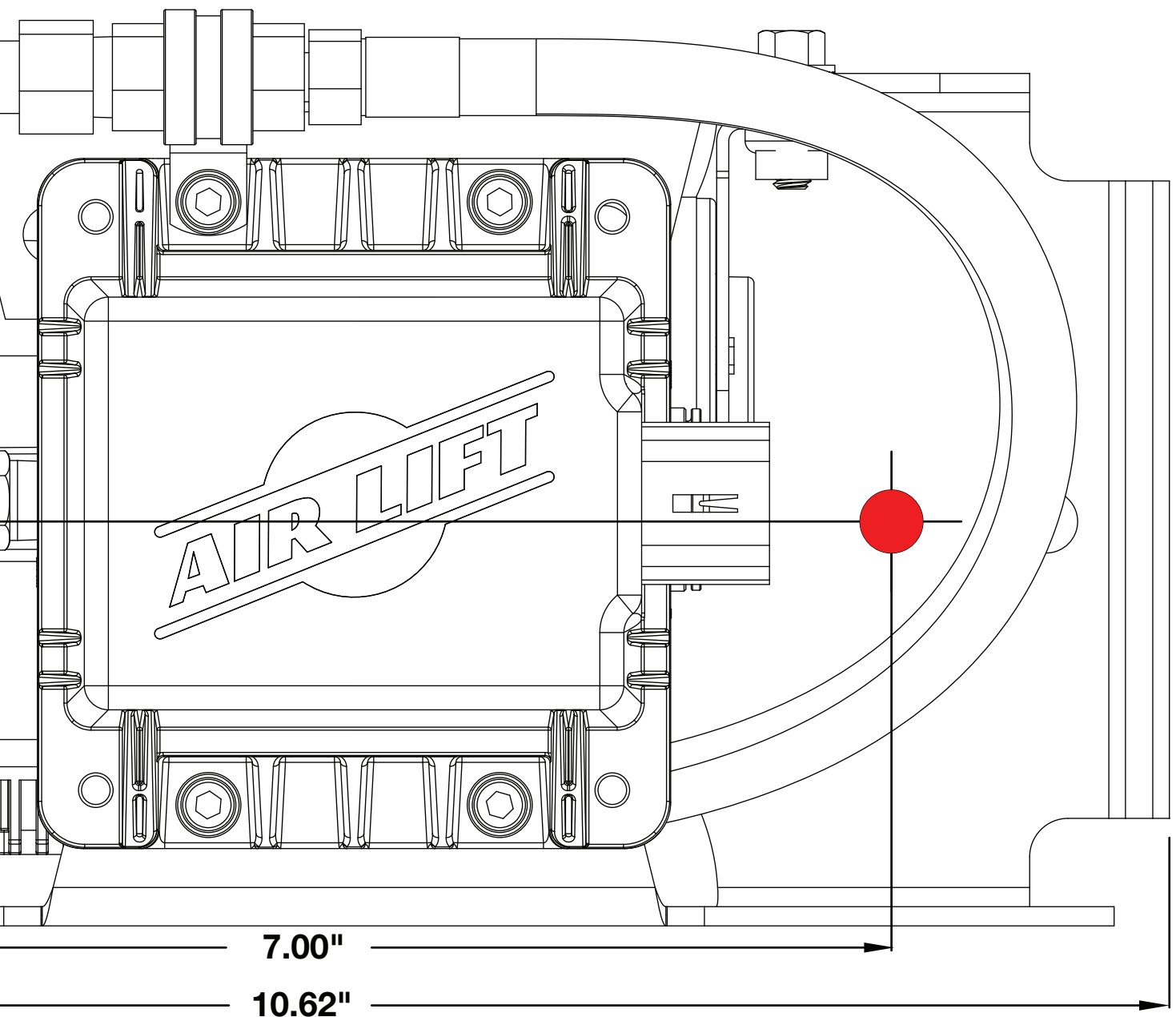





- Connect the wiring harness (C) to the manifold (Fig. 2). Press the connector on completely and listen for an audible “click.” Press white lock on connector toward manifold to lock connector in place. Ensure a proper drip loop exists to prevent water intrusion (Fig. 6). Install the fuse (E) last. The system will automatically fill to 5 PSI (.34BAR) once the fuse is installed.

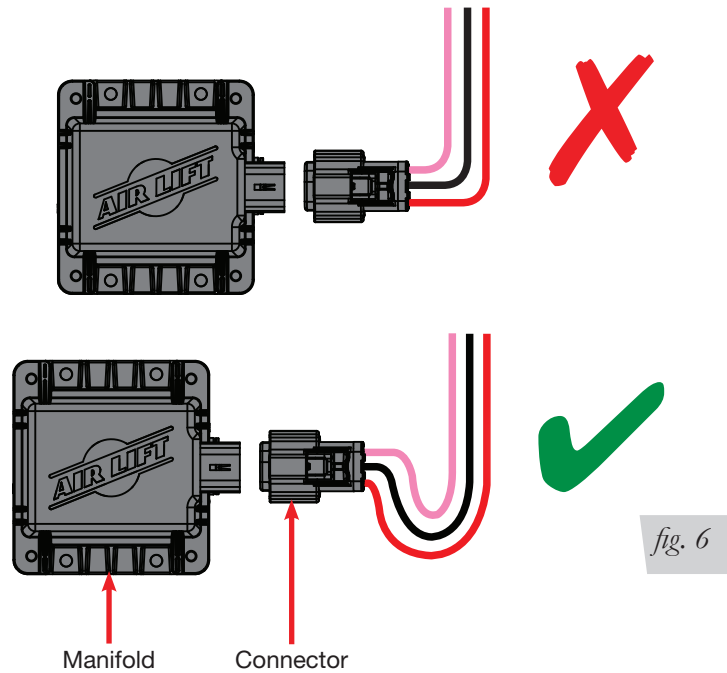

## FINAL STEPS: MOBILE APP PAIRING

For details on pairing your supported Apple (Fig. 7) or Android (Fig. 8) device, please refer to your User Guide (AD-963) included with your kit.

Scan the QR code to view a short video demonstrating how to complete mobile app pairing.

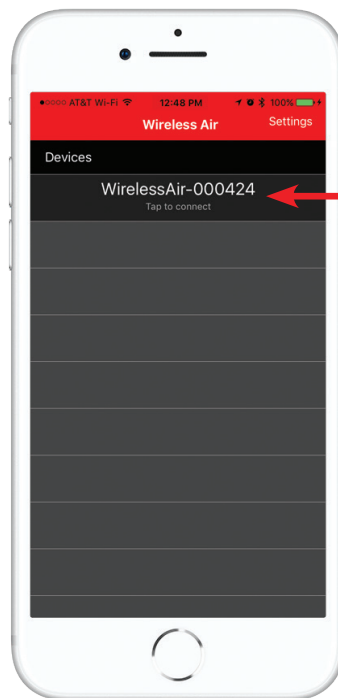

fig. 7

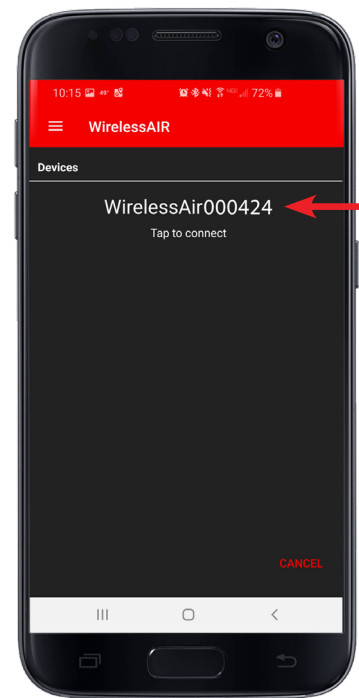
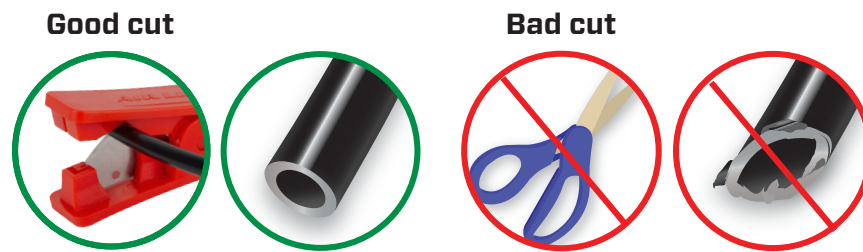

fig. 8

## CUTTING THE AIR LINES

Use a hose cutter and make clean, square cuts (Fig. 9). Do not use scissors or wire cutters because these tools will deform the air line. Do not cut the lines at an angle. The minimum bend radius for 1/4" air line is 1". Air lines are to be installed straight into fittings. Inspect the air line for scratches that run lengthwise. Contact Air Lift customer service if the air line is damaged.



*fig. 9*



To watch a video demonstrating proper air line cutting, go to [air-lift.co/cuttingairline](https://air-lift.co/cuttingairline).



## Need Help?

Contact Air Lift Company customer service department by calling (800) 248-0892. For calls from outside the USA or Canada, dial (517) 322-2144.



*Thank you for purchasing Air Lift products – the professional installer's choice!*

Air Lift Company reserves the right to make changes and improvements to its products and publications at any time. For the latest version of this manual, contact Air Lift Company at **(800) 248-0892** or visit [www.airliftcompany.com](http://www.airliftcompany.com).

Air Lift Company • 2727 Snow Road • Lansing, MI 48917 or P.O. Box 80167 • Lansing, MI 48908-0167  
Toll Free (800) 248-0892 • Local (517) 322-2144 • Fax (517) 322-0240 • [www.airliftcompany.com](http://www.airliftcompany.com)

Printed in the USA  
JJC-0625

California: ⚠️WARNING: Cancer and Reproductive Harm – [www.P65Warnings.ca.gov](http://www.P65Warnings.ca.gov)

